

Canon EFS LENS

EF-S55-250mm f/4-5.6 IS STM



IMAGE STABILIZER

ENG

Instructions

Thank you for purchasing a Canon product.

The Canon EF-S55-250mm f/4-5.6 IS STM is a high-performance telephoto zoom lens that makes movie shooting comfortable. The lens is equipped with an Image Stabilizer and has been developed for EOS cameras compatible with EF-S lenses*.

* Only the following EOS cameras are compatible with EF-S lenses (as of July 2013):
EOS 7D, EOS 60D, EOS 60Da, EOS 50D, EOS 40D, EOS 30D, EOS 20D, EOS 20Da, EOS REBEL T5i/700D, EOS REBEL SL1/100D, EOS REBEL T4i/650D, EOS REBEL T3i/600D, EOS REBEL T2i/550D, EOS REBEL T1i/500D, EOS REBEL XSi/450D, EOS REBEL T3/1100D, EOS REBEL XS/1000D, EOS DIGITAL REBEL XTi/400D DIGITAL, EOS DIGITAL REBEL XT/350D DIGITAL, EOS DIGITAL REBEL/300D DIGITAL, EOS M (when using with Mount Adapter EF-EOS M)

- "IS" stands for Image Stabilizer.
- "STM" stands for stepping motor.

Features

1. Improved Movie Shooting Functions
 - Stepping motor with lead screws achieves quiet, smooth Movie Servo AF. *1

2. High-speed, quiet Autofocusing achieved during viewfinder shooting.
3. UD lens elements for excellent imaging performance.
4. Equipped with an Image Stabilizer that provides an image stabilization effect equivalent to a shutter speed 3.5 stops*2 faster (telephoto end, when used with the EOS 7D). The Image Stabilizer also provides optimal image stabilization that responds to shooting conditions (such as shooting still subjects and following shots).
5. Electronic manual focusing (MF) made possible by electronically detecting the rotation of the focusing ring.
6. Manual focusing is available after the subject comes into focus in autofocus mode (ONE SHOT AF).
7. Circular aperture for producing beautiful softfocus images.

*1: Function compatible with the following camera (as of July 2013):

EOS REBEL T5i/700D, EOS REBEL SL1/100D, EOS REBEL T4i/650D, EOS M (when using with Mount Adapter EF-EOS M)

*2: Image stabilization performance based on CIPA (Camera & Imaging Products Association) Standards. During actual shooting, image stabilization performance varies depending on the amount of camera shake, shooting conditions, and other factors.

Handling Cautions

- **If the lens is taken from a cold environment into a warm one, condensation may develop on the lens surface and internal parts.** To prevent condensation in this case, first put the lens into an airtight plastic bag before taking it from a cold to warm environment. Then take out the lens after it has warmed gradually. Do the same when taking the lens from a warm environment into a cold one.
- Do not leave the lens in excessive heat such as in a car in direct sunlight. **High temperatures can cause the lens to malfunction.**

Usage Precautions

- When using this lens with an EOS REBEL T4i/650D camera, please be sure to update the camera's firmware to version 1.0.4 or later.
- If the EOS REBEL T4i/650D firmware is an earlier version than 1.0.4, there is a slight chance that the camera will stop operating. If this occurs, please remove the battery temporarily and insert it again for correct camera operation.
- For information on firmware updates, please check the Canon website.



Safety Precautions

- **Do not look at the sun or a bright light source through the lens or camera.** Doing so could result in loss of vision. Looking at the sun directly through the lens is especially hazardous.
- **Whether it is attached to the camera or not, do not leave the lens under the sun without the lens cap attached.** This is to prevent the lens from concentrating the sun's rays, which could cause a fire.

Conventions used in this instruction



Warning to prevent lens or camera malfunction or damage.



Supplementary notes on using the lens and taking pictures.

Safety Precautions

This device complies with Part 15 of the FCC Rules. Operation is subject to the following two conditions: (1) This device may not cause harmful interference, and (2) this device must accept any interference received, including interference that may cause undesired operation.

Do not make any changes or modifications to the equipment unless otherwise specified in the instructions. If such changes or modifications should be made, you could be required to stop operation of the equipment.

This equipment has been tested and found to comply with the limits for a class B digital device, pursuant to part 15 of the FCC Rules. These limits are designed to provide reasonable protection against harmful interference in a residential installation. This equipment generates, uses and can radiate radio frequency energy and, if not installed and used in accordance with the instructions, may cause harmful interference to radio communications.

However, there is no guarantee that interference will not occur in a particular installation. If this equipment does cause harmful interference to radio or television reception, which can be determined by turning the equipment off and on, the user is encouraged to try to correct the interference by one or more of the following measures:

- Reorient or relocate the receiving antenna.
- Increase the separation between the equipment and receiver.
- Consult the dealer or an experienced radio/TV technician for help.

This Class B digital apparatus complies with Canadian ICES-003.

Shooting Precautions

The EF-S55-250mm f/4-5.6 IS STM utilizes a stepping motor that drives the focus lens. The motor also controls the focus lens during zooming.

1. When the camera is OFF

The motor does not operate while the camera is OFF or when the camera is OFF due to the use of the auto power off function. Therefore, users must be aware of the following points.

- Manual focus adjustments are not possible.
- During zooming, delayed focus will occur.

2. When the lens is in sleep mode

If not operated for a certain period of time, this lens will enter sleep mode in order to save power. Sleep mode differs from when the camera is OFF due to the use of the auto power off function. In this state, the motor will not operate even if the camera is ON. Therefore, users must be aware of the following points.

- Manual focus adjustments are not possible.
- During zooming, delayed focus will occur.
- To exit sleep mode, press the shutter button halfway.

3. During initial reset

When the camera is ON or when the camera is turned ON by pressing the shutter button halfway down when the camera is OFF due to the use of the auto power off function*1, the lens performs an initial reset of the focus lens.

- Although the image in the viewfinder will appear out of focus during the initial reset, this does not mean that the lens has malfunctioned.
- Although the shutter can be released during the initial reset, users must wait approximately 1 second*2 after the initial reset has completed before shooting.

*1: Applicable to the following EF-S lens compatible EOS cameras:

EOS 7D, EOS 60D, EOS 60Da, EOS 50D, EOS 40D, EOS 30D, EOS 20D, EOS 20Da, EOS REBEL T3i/600D, EOS REBEL T2i/550D, EOS REBEL T1i/500D, EOS REBEL XSi/450D, EOS REBEL T3/1100D, EOS REBEL XS/1000D, EOS DIGITAL REBEL XTi/400D DIGITAL, EOS DIGITAL REBEL XT/350D DIGITAL, EOS DIGITAL REBEL/300D DIGITAL

*2: The initial reset time varies depending on camera being used.

Nomenclature

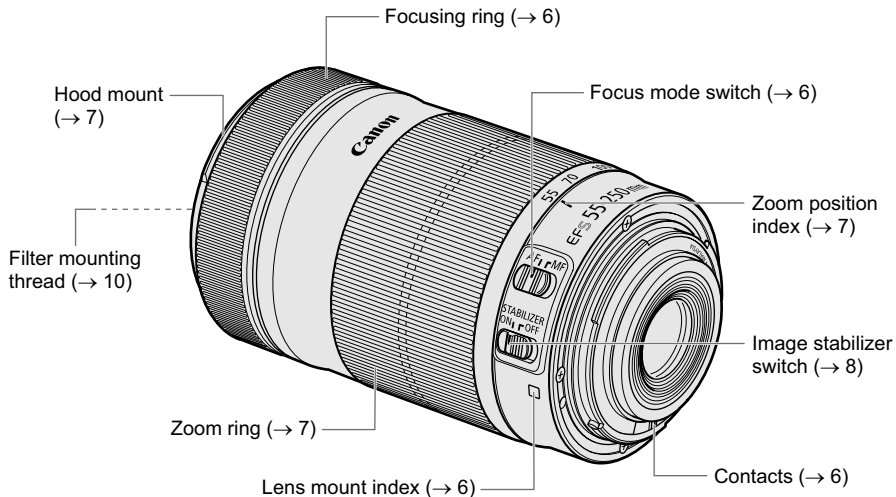

● For detailed information, reference page numbers are provided in parentheses (→ **).

1 Mounting and Detaching the Lens

See your camera's instructions for details on mounting and detaching the lens.

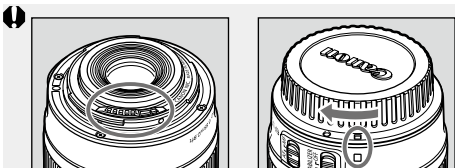

- After detaching the lens, place the lens with the rear end up to prevent the lens surface and contacts from getting scratched.
- If the contacts get soiled, scratched, or have fingerprints on them, corrosion or faulty connections can result. The camera and lens may not operate properly.
- If the contacts get soiled or have fingerprints on them, clean them with a soft cloth.
- If you remove the lens, cover it with the dust cap. To attach it properly, align the lens mount index and the □ index of the dust cap as shown in the diagram, and turn clockwise. To remove it, reverse the order.

2 Setting the Focus Mode

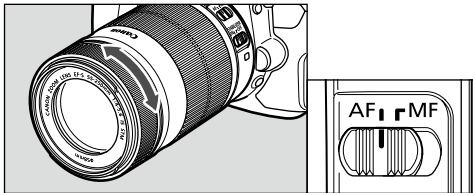

To shoot in autofocus (AF) mode, set the focus mode switch to AF.

To use only manual focusing (MF), set the focus mode switch to MF, and focus by turning the focusing ring.

After autofocus in ONE SHOT AF mode, focus manually by pressing the shutter button halfway and turning the focusing ring. (Full-time manual focus)

- Quickly rotating the focusing ring may result in delayed focus.
- Manual focus adjustments are not possible when the camera is OFF.

3 Zooming

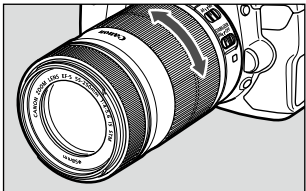

To zoom, turn the lens' zoom ring.

- Be sure to finish zooming before focusing. Zooming after focusing can affect the focus.
- Blurring may temporarily occur if the zoom ring is quickly rotated.
- Zooming when the camera is OFF will result in delayed focus.
- Zooming during still image exposure will result in delayed focus. This causes any streaks of light that are captured during exposure to be blurred.

4 Hood (sold separately)

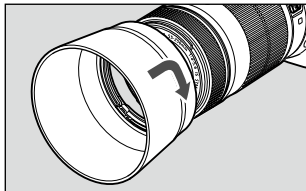

The ET-63 hood cuts out unwanted light and protects the front of the lens from rain, snow, and dust.

Turn the hood in the direction of the arrow to attach it securely.

The hood can be reverse-mounted on the lens for storage.

- If the hood is not attached properly, vignetting (darkening of the perimeter of the picture) may occur.
- When attaching or detaching the hood, grasp the base of the hood to turn it. To prevent deformation, do not grasp the rim of the hood to turn it.

5 Image Stabilizer

You can use the image stabilizer in AF or MF mode.

This function provides optimal image stabilization depending on shooting conditions (such as shooting still subjects and following shots).

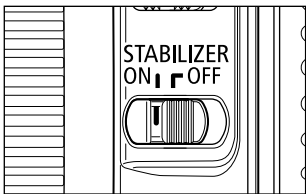

1 Set the **STABILIZER** switch to **ON**.

- If you are not going to use the image stabilizer function, set the switch to OFF.

2 When you press the shutter button halfway, the **Image Stabilizer** will start operating.

- Make sure the image in the viewfinder is stable, then press the shutter button the rest of the way down to take the picture.

- The Image Stabilizer cannot compensate for a blurred shot caused by a subject that moved.
- The Image Stabilizer may not be fully effective if you shoot from a violently shaking vehicle or other transportation.
- The Image Stabilizer consumes more power than normal shooting, so fewer shots can be taken if you use the function.

- When shooting a still subject, it compensates for camera shake in all directions.
- It compensates for vertical camera shake during following shots in a horizontal direction, and compensates for horizontal camera shake during following shots in a vertical direction.
- When you use a tripod, the Image Stabilizer should be turned off to save battery power.
- Even with a monopod, the Image Stabilizer will be as effective as during hand-held shooting. However, depending on the shooting environment, the Image Stabilizer effect may be less effective.
- The image stabilizer function also operates when the lens is used with an Extension Tube EF12 II or EF25 II.
- If you set the camera's Custom Function to change the assigned button to operate the AF, the Image Stabilizer will operate when you press the newly assigned AF button.

Image Stabilizer

The image stabilizer for this lens is effective for hand-held shots in the following conditions.



ON

OFF

- In semi-darkened areas such as indoors or outdoors at night.
- In locations where flash photography is prohibited, such as art museums and theater stages.
- In situations where your footing is uncertain.
- In situations where fast shutter settings cannot be used.



ON

OFF

- When panning subjects in motion.

6 Filters (sold separately)

You can attach filters to the filter mounting thread on the front of the lens.

- Only one filter may be attached.
- If you need a polarizing filter, use the Canon Circular Polarizing Filter PL-C B (58 mm).
- To adjust the polarizing filter, first remove the lens hood.

7 Extension Tubes (Sold Separately)

You can attach extension tube EF12 II or EF25 II for magnified shots. The shooting distance and magnification are shown below.

| | | Focusing Distance Range (mm) | | Magnification (×) | |
|---------|-------|------------------------------|---------------|-------------------|---------------|
| | | Close distance | Long distance | Close distance | Long distance |
| EF12 II | 55mm | 335 | 421 | 0.30 | 0.22 |
| | 250mm | 751 | 5230 | 0.38 | 0.05 |
| EF25 II | 55mm | 266 | 292 | 0.58 | 0.48 |
| | 250mm | 684 | 2647 | 0.48 | 0.11 |

 MF mode is recommended for accurate focusing.

8 Close-up Lenses (Sold separately)

Attaching a 250D or 500D (58mm) Close-up Lens enables close-up photography. The magnification will be as follows.

- Close-up Lens 250D: 0.23x - 1.04x
- Close-up Lens 500D: 0.11x - 0.66x

 MF mode is recommended for accurate focusing.

9 Specifications

| | |
|---------------------------------|---|
| Focal Length/Aperture | 55-250mm f/4-5.6 |
| Lens Construction | 12 groups, 15 elements |
| Minimum Aperture | f/22-32 |
| Angle of View | Diagonal: 27°50' - 6°15', Vertical: 15°40' - 3°30', Horizontal: 23°20' - 5°20' |
| Min. Focusing Distance | 0.85 m/2.79 ft. |
| Max. Magnification | 0.29x (at 250 mm) |
| Field of View | Approx. 197 x 296 - 52 x 78 mm/7.76 x 11.69 - 2.05 x 30.7 inch (at 0.85 m/2.79 ft.) |
| Filter Diameter | 58 mm |
| Max. Diameter and Length | Approx. 70.0 x 111.2 mm/2.76 x 4.38 inch |
| Weight | Approx. 375 g/13.2 oz |
| Hood | ET-63 (Sold Separately) |
| Lens Cap | E-58 II |
| Case | LP1019 (Sold Separately) |

- Equivalent to 88-400 mm in the 35mm film format.
- The lens length is measured from the mount surface to the front end of the lens. Add 24.2 mm when including the lens cap and dust cap.
- The size and weight listed are for the lens only, except as indicated.
- Extenders cannot be used with this lens.
- Aperture settings are specified on the camera. The camera automatically compensates for variations in the aperture setting when the camera is zoomed in or out.
- All data listed is measured according to Canon standards.
- Product specifications and appearance are subject to change without notice.

Canon